

# PHCbi

## Operating Instructions

Ultra-Low Temperature Freezer

# MDF-DU300H

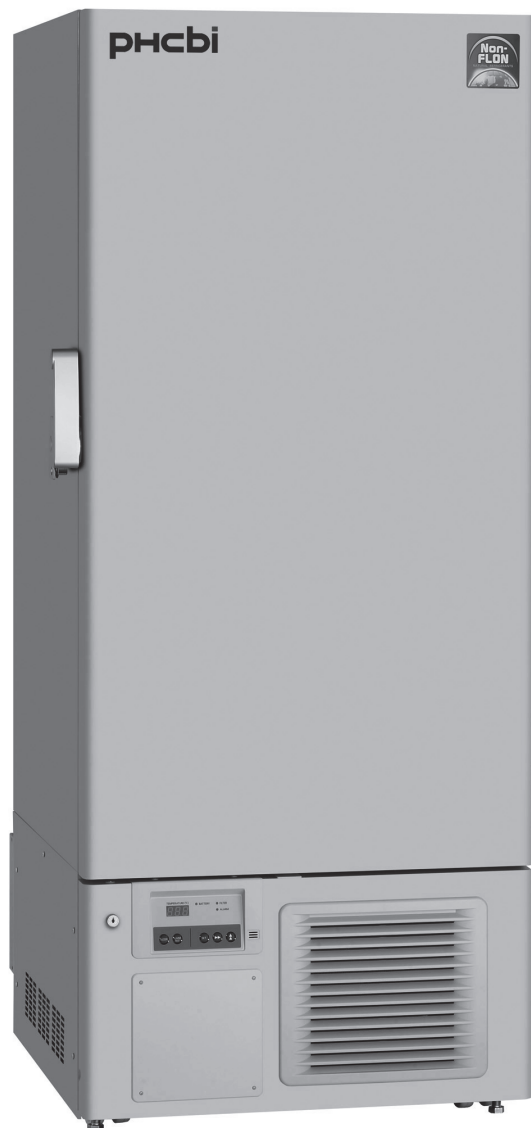

Please read the operating instructions carefully before using this product, and keep the operating instructions for future use.

See page 43 for model number.



# CONTENTS

INTRODUCTION	P. 2
PRECAUTIONS FOR SAFE OPERATION	P. 3
LABELS ON THE UNIT	P. 7
SYMBOLS ON THE UNIT	P. 7
ENVIRONMENTAL CONDITIONS	P. 8
INTENDED USE AND PRECAUTIONS	P. 8
FREEZER COMPONENTS	P. 9
Freezer unit	P. 9
Control panel	P.11
INSTALLATION SITE	P.12
INSTALLATION	P.13
START-UP OF UNIT	P.15
CHAMBER TEMPERATURE SETTING	P.16
LOCK OF CHAMBER TEMPERATURE	P.16
ALARM TEMPERATURE SETTING	P.17
Setting of high temperature alarm	P.17
Setting of low temperature alarm	P.18
SETTING OF RINGBACK OF ALARM BUZZER	P.19
SETTING OF COMPRESSOR DELAY TIME	P.20
REMOTE ALARM TERMINAL	P.21
OPERATION CHECK AFTER RECOVERY	P.21
ALARM FUNCTIONS	P.22
SAFETY FUNCTIONS	P.22
SELF DIAGNOSTIC FUNCTIONS	P.23
ROUTINE MAINTENANCE	P.24
Cleaning of exterior, interior, and accessories	P.24
Cleaning of condenser filter	P.24
Defrosting of inside wall	P.25
CALIBRATION	P.25
REPLACEMENT OF WEAR-OUT PARTS	P.26
Replacement of battery for power failure alarm	P.26
Replacement of fan motor	P.26
TROUBLESHOOTING	P.27
DISPOSAL OF UNIT	P.28
Recycle of battery	P.28
Decontamination of unit	P.28
TEMPERATURE RECORDER (OPTION)	P.33
Temperature recorder unit of MTR-G85C	P.34
Loading the pen cartridge	P.35
Setting the start time	P.36
Replacing the recording chart	P.36
Temperature recorder unit of MTR-85H	P.37
Loading the in pen	P.37
Loading the recording paper	P.38
Replacing the dry cell	P.39
BACKUP COOLING KIT (OPTION)	P.40
INVENTORY RACK (OPTION)	P.41
SPECIFICATIONS	P.42
PERFORMANCE	P.43
EMC PERFORMANCE	P.43
SAFETY CHECK SHEET	P.44

# INTRODUCTION

- Read the operating instructions carefully before using the product and follow the instructions for safe operation.
- PHC Corporation takes no responsibility for safety if the product is not used as intended or is used with any procedures other than those given in the operating instructions.
- Keep the operating instructions in a suitable place so that they can be referred to as necessary.
- The operating instructions are subject to change without notice for improvement of performance or function.
- Contact our sales representative or agent if any page of the operating instructions is lost or the page order is incorrect, or if the instructions are unclear or inaccurate.
- No part of the operating instructions may be reproduced in any form without the express written permission of PHC Corporation.

## **IMPORTANT NOTICE**

PHC Corporation guarantees this product under certain warranty conditions. However, please note that PHC Corporation shall not be responsible for any loss or damage to the contents of the product.

# PRECAUTIONS FOR SAFE OPERATION

**It is imperative that the user complies with the operating instructions as it contains important safety advice.**

Items and procedures are described so that you can use this unit correctly and safely. If the precautions advised are followed, this will prevent possible injury to the user and any other person.

Precautions are illustrated in the following way:



## **WARNING**

Failure to observe WARNING signs could result in a hazard to personnel possibly resulting in serious injury or death.

## **CAUTION**

Failure to observe CAUTION signs could result in injury to personnel and damage to the unit and associated property.

Symbol shows;

-  This symbol means caution.
-  This symbol means an action is prohibited.
-  This symbol means an instruction must be followed.















Be sure to keep the operating instructions in a place accessible to users of this unit.

## **WARNING**

As with any equipment that uses CO<sub>2</sub> gas, there is a likelihood of oxygen depletion in the vicinity of the equipment. It is important that you assess the work site to ensure there is suitable and sufficient ventilation. If restricted ventilation is suspected, then other methods of ensuring a safe environment must be considered. These may include atmosphere monitoring and warning devices.















# PRECAUTIONS FOR SAFE OPERATION

## **WARNING**

-  **Do not use the unit outdoors.** Current leakage or electric shock may result if the unit is exposed to rain water.
-  **Only qualified engineers or service personnel should install the unit.** The installation by unqualified personnel may cause electric shock or fire.
-  **Install the unit on a sturdy floor and take an adequate precaution to prevent the unit from turning over.** If the floor is not strong enough or the installation site is not adequate, this may result in injury from the unit falling or tipping over.
-  **Never install the unit in a humid place or a place where it is likely to be splashed by water.** Deterioration of the insulation may result which could cause current leakage or electric shock.
-  **Never install the unit in a flammable or volatile location.** This may cause explosion or fire.
-  **Never install the unit where acid or corrosive gases are present** as current leakage or electric shock may result due to corrosion.
-  **Always ground (earth) the unit to prevent electric shock.** If the power supply outlet is not grounded, it will be necessary to install a ground by qualified engineers.
-  **Never ground the unit through a gas pipe, water main, telephone line or lightning rod.** Such grounding may cause electric shock in the case of an incomplete circuit.
-  **Connect the unit to a power source as indicated on the rating label attached to the unit.** Use of any other voltage or frequency other than that on the rating label may cause fire or electric shock.
-  **Never store volatile or flammable substances** in this unit if the container cannot be sealed. These may cause explosion or fire.
-  **Do not insert metal objects such as a pin or a wire into any vent, gap or any outlet on the unit.** This may cause electric shock or injury by accidental contact with moving parts.
-  **Use this unit in safe area when treating the poison, harmful or radiate articles.** Improper use may cause bad effect on your health or environment.
-  **Turn off the power switch (if provided) and disconnect the power supply to the unit prior to any repair or maintenance** of the unit in order to prevent electric shock or injury.
-  **Do not touch any electrical parts (such as power supply plug) or operate switches with a wet hand.** This may cause electric shock.
-  **Ensure you do not inhale or consume medication or aerosols** from around the unit at the time of maintenance. These may be harmful to your health.







# PRECAUTIONS FOR SAFE OPERATION

## **WARNING**

-  **Never splash water directly onto the unit** as this may cause electric shock or short circuit.
-  **Never put containers with liquid on the unit** as this may cause electric shock or short circuit when the liquid is spilled.
-  **Never bind, process, or step on the power supply cord, or never damage or break the power supply plug.** A broken supply cord or plug may cause fire or electric shock.
-  **Do not use the supply cord if its plug is loose.** Such supply cord may cause fire or electric shock.
-  **Never disassemble, repair, or modify the unit yourself.** Any such work carried out by an unauthorized person may result in fire, or electric shock or injury due to a malfunction.
-  **Disconnect the power supply plug if there is something wrong with the unit.** Continued abnormal operation may cause electric shock or fire.
-  **When removing the plug from the power supply outlet, grip the power supply plug, not the cord.** Pulling the cord may result in electric shock or fire by short circuit.
-  **Disconnect the power supply plug** before moving the unit. Take care not to damage the power supply cord. A damaged cord may cause electric shock or fire.
-  **Disconnect the power supply plug when the unit is not used for long periods.** Keeping the connection may cause electric shock, current leakage, or fire due to the deterioration of insulation.
-  If the unit is to be stored unused in an unsupervised area for an extended period, **ensure that children do not have access and that doors cannot be closed completely with a key.**
-  **The disposal of the unit should be accomplished by appropriate personnel.** Remove doors to prevent accidents such as suffocation.
-  **Do not put the packing plastic bag within reach of children** as suffocation may result.
-  **Flammable and explosive product.** This product contains flammable refrigerant. Do not damage or break the pipework.
-  **This product contains flammable refrigerant.** Well ventilate the room to prevent refrigerant accumulation.
-  **Do not position this unit and the other unit so that it is difficult to operate the disconnection of the power supply plug.** Failure to disconnect the power supply plug may cause fire if there is something wrong with the unit.

# PRECAUTIONS FOR SAFE OPERATION

## CAUTION





-  This unit must be plugged into a dedicated circuit protected by branch circuit breaker.
-  Use a dedicated power source as indicated on the rating label attached to the unit. A multiple-tap may cause fire resulting from abnormal heating.
-  **Connect the power supply plug to the power source firmly after removing the dust on the plug.**  
A dusty plug or improper insertion may cause a heat or ignition.
-  **Never store corrosive substances such as acid or alkali** in this unit if the container cannot be sealed. These may cause corrosion of inner components or electric parts.
-  **Check the setting when starting up of operation after power failure or turning off of power switch.** The stored items may be damaged due to the change of setting.
-  **Be careful not to tip over the unit** during movement to prevent damage or injury.
-  **Prepare a safety check sheet (copy the last page)** when you request any repair or maintenance for the safety of service personnel.



# LABELS ON THE UNIT



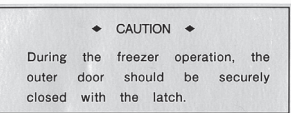

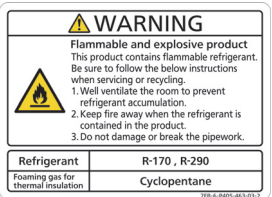
Warning safety labels applied to the ultra-low temperature freezer

Users are advised to avoid accidents by carefully reading the warnings and cautions contained on warning labels at key locations on the interior and exterior of the ultra-low temperature freezer.

Possible Danger	Warning/Caution Type Location of Danger	Warning/Caution Label	Description of Danger
Personal injury	<b>Hazardous Latch</b> Latch		Dangerous to put a hand.
Personal injury	<b>Frostbite and frost</b> Interior		Frostbite and frost caution label.
Sample damage	<b>Chamber temperature</b> Interior		Forgets to close a door and latch.
Sample damage	<b>Chamber temperature</b> Interior		Rise in temperature is prevented.
Personal injury	<b>Flammable and explosive product</b> Interior		This product contains flammable refrigerant. Please follow the instructions when recycling.

# SYMBOLS ON THE UNIT

The symbols are attached to the ultra-low temperature freezer. The following table describes the symbols.

	This symbol is attached to covers that access high-voltage electrical components to prevent electric shock. Only a qualified engineer or service personnel should be allowed to open these covers.
	This symbol indicates that caution is required. Refer to product documentation for details.
	This symbol indicates an earth.
	This symbol indicates Incorrect usage could lead to a fire hazard.
	This symbol means "ON" for a power switch.
○	This symbol means "OFF" for a power switch.

---

# ENVIRONMENTAL CONDITIONS

---

This equipment is designed to be safe at least under the following conditions (based on the IEC 61010-1):

- Indoor use;
- Altitude up to 2000 m;
- Ambient temperature 5 °C to 40 °C;
- Maximum relative humidity 80 % for temperature up to 31 °C decreasing linearly to 50 % relative humidity at 40 °C;
- Mains supply voltage fluctuations up to  $\pm 10$  % of the nominal voltage;
- Transient overvoltages up to the levels of OVERVOLTAGE CATEGORY II;
- Temporary OVERVOLTAGES occurring on the mains supply;
- Applicable pollution degree of the intended environment (POLLUTION DEGREE 2 in most cases);

---

# INTENDED USE AND PRECAUTIONS

---

This equipment is designed for low temperature storage of human cells, organs, plasma and DNAs.

Temperature and duration of storage:

cells: 1month - 1year at -80 °C

organs: 11months at -80 °C

DNA: Long term (8 years) at -70 - -80 °C

plasma: 2-3 months at -80 °C

- The effective storage period depends on the sample condition and storage temperature. It is necessary to determine the storage temperature and period suitable for the purpose.
- For the live cells, the lower storage temperature should be required for long term storage. It is recommended to store the live cells at -130 °C or lower.

# FREEZER COMPONENTS

## Freezer unit

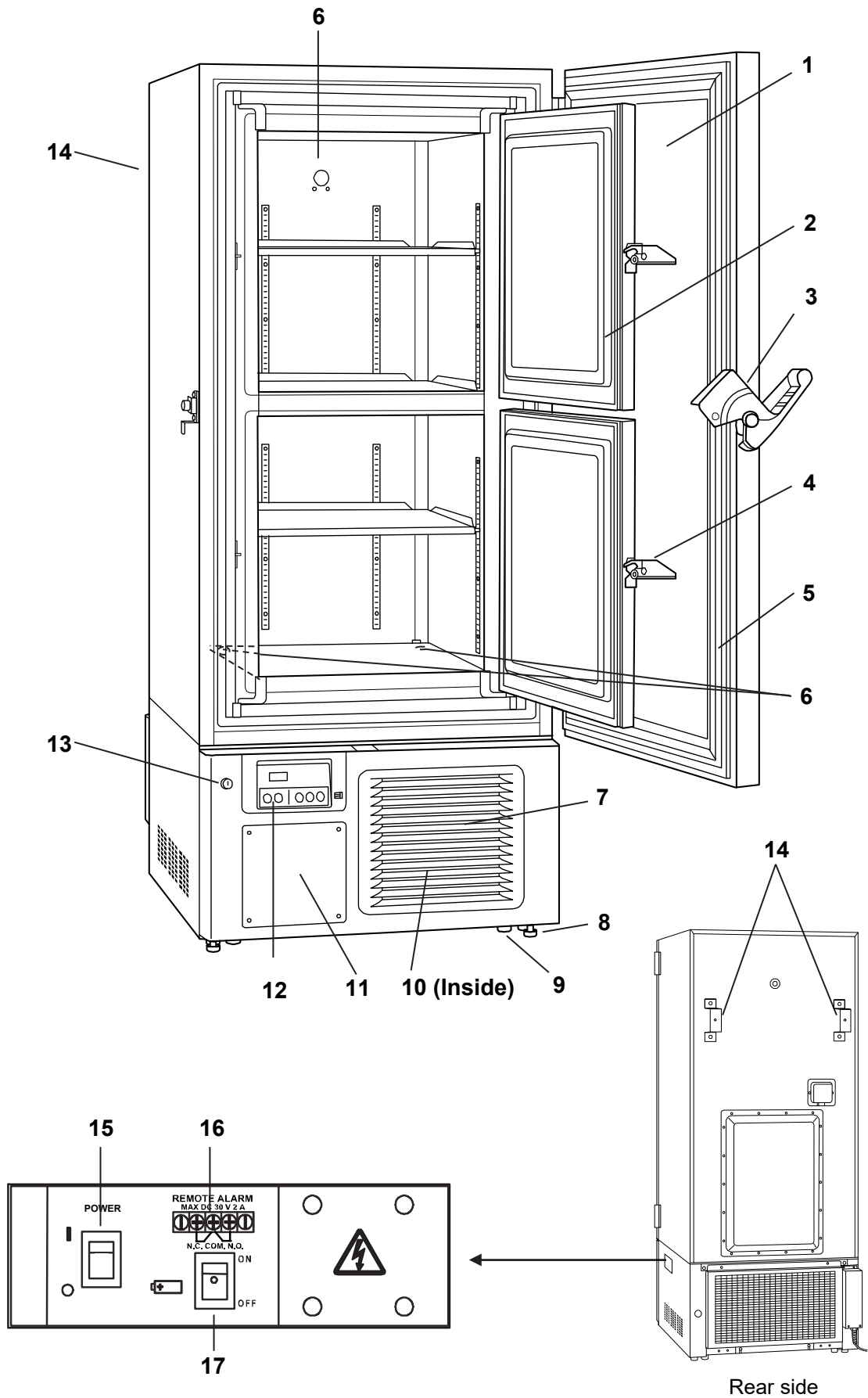

# FREEZER COMPONENTS

- 1. Outer door:** To open the outer door, grip the outer door latch. When closing, lock the outer door latch completely.
- 2. Inner door:** The operation of the inner door should be quick to minimize the temperature rise in chamber. Lock the inner door latch completely when the outer door is closed. The inner door is removable for cleaning or defrosting. See page 25 for details.
- 3. Outer door latch:** Always lock the outer door latch when the outer door is closed. A pad lock can be attached to the outer door latch.
- 4. Inner door latch:** Always lock the inner door latch when the inner door is closed.
- 5. Magnetic door gasket:** This provides a tight door seal and prevents cold air leak. Keep clean.
- 6. Access port (rear and bottom):** This is used for leading a cable and sensor of a measuring equipment, or nozzle of backup cooling kit to chamber.  
◇ Replace insulation and the rubber caps when the access port is not used. Improper replacement may cause rise of chamber temperature or condensation around the access port.
- 7. Air intake vent (grille):** Do not block this vent to keep the proper cooling performance.
- 8. Leveling feet:** These are screw bolts used to install and fix the unit. Adjust the height of the leveling feet by turning the screw bolts until 2 front casters are away from the floor
- 9. Caster:** 4 casters are provided to facilitate moving of the cabinet. For the installation, adjust the leveling feet so that the front 2 casters cannot contact with the floor.
- 10. Condenser filter (behind the grille):** This filter prevents the dust from accumulating on the condenser. The dusty condenser filter may cause failure of refrigerating device. Clean the condenser filter once a month. See page 24 for details.
- 11. Space for temperature recorder:** A temperature recorder (optional component) can be attached here. See page 33 for details.
- 12. Control panel:** Used for temperature setting, and indication of operating status is displayed on the digital temperature indicator. See page 11 for details.
- 13. Keyhole:** Turn counterclockwise to 180 ° with a key and the outer door is securely locked.
- 14. Fixture (on back side):** 2 fixtures serve as spacers between the cabinet and wall and also serve as hooks to fix the unit. See page 13 for details.
- 15. Power switch:** This is for turning ON/OFF the power to the unit. ON – “I” OFF – “O”
- 16. Remote alarm terminal:** This is used to notice an alarm condition of the unit to remote location. Refer to page 21 for details.
- 17. Battery switch:** This is a switch for a battery for power failure alarm. Normally, turn on this switch. Be sure to turn off this switch if the freezer is not in operation for a long period.

# FREEZER COMPONENTS

## Control panel

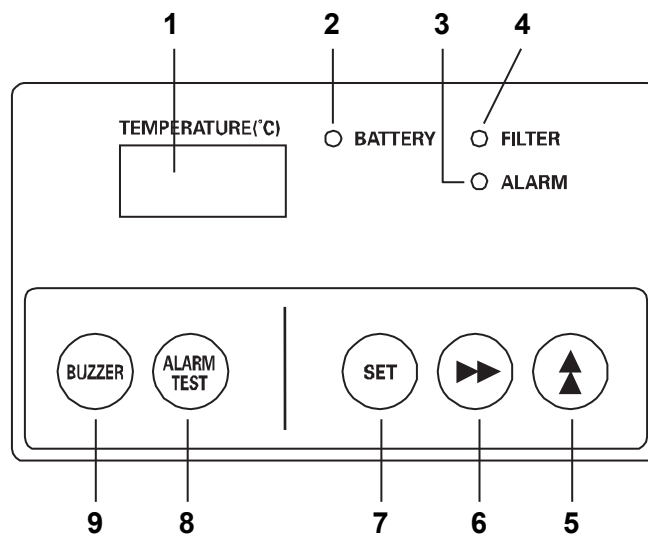

**1. Digital temperature indicator:** This indicator shows the present chamber temperature, error code or set temperature.

**2. Battery check lamp (BATTERY):** This lamp lights to recommend the battery replacement (about 3 years after switch on). This lamp blinks to recommend the fan motor replacement (about 6 years after switch on). For the replacement, consult our sales representative or agent.

**3. Alarm lamp (ALARM):** This lamp blinks during alarm condition.

**4. Filter check lamp (FILTER):** This lamp lights and alarm buzzer sounds when the excessive dust is accumulated on the condenser filter. When this lamp lights and alarm buzzer sounds, clean the condenser filter following the procedure on page 24.

**5. Numerical value shift key (▲):** Pressing this key in the setting mode causes the numerical value to shift. ON-OFF of key lock for chamber temperature setting can be selected by pressing this key in the key lock setting mode. By pressing this key for more than 5 seconds in the temperature display mode leads the setting mode for alarm temperature, ringback of alarm buzzer and compressor delay time. Refer to page 17 through page 20 for details respectively.

**6. Digit shift key (▶▶):** Pressing this key in the setting mode causes the changeable digit to shift. Key lock setting mode is led by pressing this key for more than 5 seconds in the temperature display mode. Refer to page 16 for details.

**7. Set key (SET):** Chamber temperature setting mode is led by pressing this key and the changeable digit blinks. Pressing this key again after temperature setting memorizes the setting.

**8. Alarm test key (ALARM TEST):** To check the alarm system during freezer operation. Pressing this key with the battery switch ON gets the alarm lamp to blink, the remote alarm to operate, and the alarm buzzer to sound.

**9. Alarm buzzer stop key (BUZZER):** To silence the audible alarm under alarm condition, press this key.

◇ "Temperature display mode": The status which the digital temperature indicator shows the current chamber temperature

◇ "Setting mode"; The status which the digital temperature indicator is ready to be entered after pressing the numerical value shift key for 5 seconds.

# INSTALLATION SITE

To operate this unit properly and to obtain maximum performance, install the unit in a location with the following conditions:

■ **A location not subjected to direct sunlight**

Do not install the unit under direct sunlight. Installation in a location subjected to direct sunlight cannot obtain the intended performance.

■ **A location with adequate ventilation**

Leave at least 10 cm around the unit for ventilation. Poor ventilation will result in a reduction of the performance and consequently the failure.

■ **A location away from heat generating sources**

Avoid installing the unit near heat-emitting appliances such as a heater or a boiler etc. Heat can decrease the intended performance of the unit.

■ **A location with little temperature change**

Install the unit under stable ambient temperature. The allowable ambient temperature is between +5 °C and +30 °C.

■ **A location with a sturdy and level floor**

Always install the unit on a sturdy and level floor. The uneven floor or tilted installation may cause failure or injury. Install the unit in stable condition to avoid the vibration or noise. Unstable condition may cause vibration or noise.

 **WARNING**

**Install the unit on a sturdy floor.** If the floor is not strong enough or the installation site is not adequate, this may result in injury from the unit falling or tipping over.

**Select a level and sturdy floor for installation.** This precaution will prevent the unit from tipping. Improper installation may result in water spillage or injury from the unit tipping over.

■ **A location not prone to high humidity**

Install the unit in the ambient of 80% R.H. or less humidity. Installation under high humidity may cause current leakage or electric shock.

 **WARNING**

**Do not use the unit outdoors.** Current leakage or electric shock may result if the unit is exposed to rain water.

**Never install the unit in a humid place or a place where it is likely to be splashed by water.** Deterioration of the insulation may result which could cause current leakage or electric shock.

■ **A location without flammable or corrosive gas**

Never install the unit in a location where it will be exposed to flammable or corrosive gas. This may cause explosion or fire or may result in the current leakage or electric shock by the corrosion of the electrical components.

■ **A location without the possibility of anything fall**

Avoid installing the unit in the location where anything can fall down onto the unit. This may cause the breakdown or failure of the unit.

# INSTALLATION

## 1. After unpackaging

Remove all transportation packaging materials and tapes. Open the doors and ventilate the unit. If the outside panels are dirty, clean them with a diluted neutral dishwashing detergent.

✧ Undiluted detergent can damage the plastic components. For the dilution, refer to the instruction of the detergent.

✧ After the cleaning with the diluted detergent, always wipe it off with a wet cloth. Then wipe off the panels with a dry cloth.

### Note:

Remove the cable tie banding the power supply cord. Prolonged banding may cause the corrosion of the cord coating.

## 2. Installing the unit

Stretch the leveling feet by rotating them to contact them to the floor. Ensure the unit is installed horizontally. [Fig. 1]

✧ The unit is installed firmly by separating the casters from the floor. The unit may be moved at the time of opening/closing the door if the casters contact with floor.

## 3. Fixing the unit

Fix the unit to the wall by using 2 fixtures [Fig. 2] and a rope or chain.

### Note:

Contact our sales representative or agent if the unit should be fixed for earthquake resistant.

## 4. Ground (earth) the unit

The ground (earth) is for preventing the electric shock in the case of the electrical insulation is somehow degraded. Always ground the unit at the time of installation.

✧ A 3-prong plug with grounding pole is provided to the power supply cord. There is no need for electric work for grounding.

✧ If the power supply outlet is not grounded, it will be necessary to install a ground by qualified engineers.

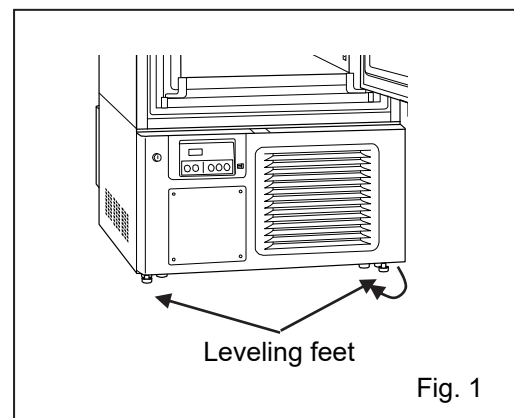

Fig. 1

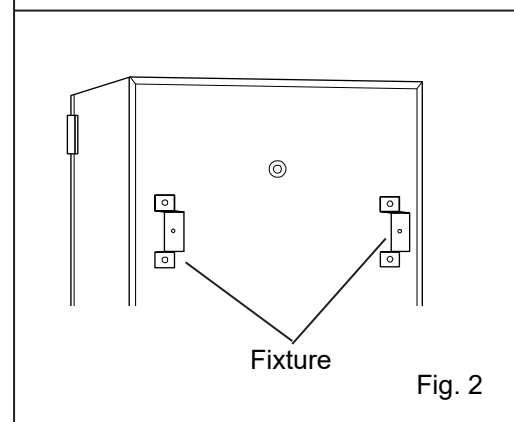

Fig. 2

## WARNING

**Use a power supply outlet with ground (earth) to prevent electric shock.** If the power supply outlet is not grounded, it is necessary to install a ground by qualified engineers.

**Never ground the unit through a gas pipe, water main, telephone line or lightning rod.** Such grounding may cause electric shock in the case of an incomplete circuit.

# INSTALLATION

## 5. Installing the earth leakage breaker

It is recommended to install an earth leakage breaker to the power supply side of the product.  
Contact our sales representative or agent at the time of installation of the earth leakage breaker.

## 6. Installing the shelves

The shelves are packaged all together in the chamber. Fix the shelves on the shelf stoppers securely before start-up of the unit.

◇ Incomplete installation may cause injury or damage.

The shelf stoppers are attached to the standard location. Change the location of shelf stopper as necessary.

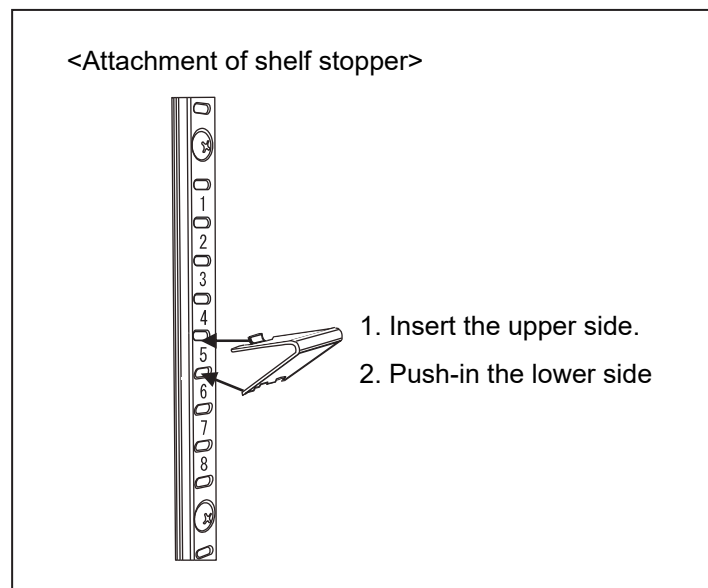



# START-UP OF UNIT

Use the following procedure to start trial operation or actual operation of the unit.

◇ At the recovery after power failure, the operation is start-up automatically with the setting before power failure.

1. Turn off the switch of a backup cooling kit (optional component) if it is installed. And check the power switch and battery switch are off.

2. Connect the power supply cord to the dedicated outlet having appropriate rating with the chamber empty, and turn on the power switch on the freezer.

3. Turn on the battery switch.

4. Set the desired chamber temperature. See page 16 for the temperature setting.

◇ The alarm lamp blinks until the chamber temperature gets to the set temperature at the first start-up. The alarm lamp is off when the chamber temperature reaches around the set temperature.

5. Check that the chamber temperature reaches the desired temperature.

6. Turn on the switch of a backup cooling kit (optional component) if it is installed.

7. Check that the alarm lamp blinks and the alarm buzzer sounds by pressing the alarm test key (ALARM TEST).

◇ E09 is displayed on the digital temperature indicator and the alarm buzzer does not sound if the battery switch is off.

8. After confirming the above, you can put articles into the freezer chamber in a small batch to prevent the temperature rise.

9. Check the operation of backup cooling kit (optional component) if it is installed by pressing the test key.

## NOTE:

■ Do not put too many warm articles in the chamber. The temperature rise may cause the damage to the articles in the chamber.

■ Never touch the stored items with wet hands. Touching with the wet hands may cause frostbite.

■ When this product operates at the first start-up or after no use for a long period, the capacity of battery for power failure alarm may be lowered or completely zero because of discharge of the battery. To charge the battery, the freezer should be operated for more than 3 days (72 hours) with the battery switch on.





# CHAMBER TEMPERATURE SETTING

Set the chamber temperature according to the condition of use. This freezer can keep the stored items for long period under low temperature.

- Setting range of chamber temperature: between -90 °C and -50 °C
- Initial setting (factory setting): -80 °C

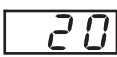
Example: Change the chamber temperature to -75 °C from -80 °C

► Following shows a sample setting. Set the desired chamber temperature according to the condition of use.

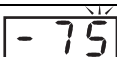
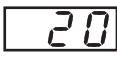
	Description of operation	Key operated	Indication after operation
1	Turn on the power switch.	----	The current chamber temperature is displayed. 
2	Press set key.	SET	The current setting (-80) is displayed and the second digit blinks. 
3	Set to -75 with the numerical value shift key and the digit shift key.		When pressed, the figure of settable digit changes.
			When pressed, the settable digit is shifted. 
4	Press set key.	SET	Set temperature is memorized and the current chamber temperature is displayed. 

◇ The setting mode returns to the temperature display mode automatically when 90 seconds has passed without any key operation (auto-return function). In this case, the setting is not accepted.

◇ Although the value of the chamber temperature setting can range from -90 °C to -50 °C, the guaranteed temperature with no load is -86 °C when the ambient temperature is 30 °C.





# LOCK OF CHAMBER TEMPERATURE

The setting of chamber temperature can be protected to avoid an accidental change. When the lock is ON, change of chamber temperature setting through the key pad is not available.

- Initial setting (factory setting): lock OFF

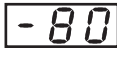
Display	Mode	Function
L 0	Lock is OFF	Enable to change the chamber temperature setting
L 1	Lock is ON	Disable to change the chamber temperature setting

Example: Change the lock to ON from OFF (factory setting)

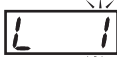
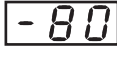
	Description of operation	Key operated	Indication after operation
1		----	The current chamber temperature is displayed. 
2	Press the digit shift key for about 5 seconds.		The first digit blinks. 
3	Press the numerical value shift key and scroll the figure to 1.		When pressed, the figure of settable digit changes. 
4	Press set key.	SET	The key lock is set to ON. The current chamber temperature is displayed. 

◇ The setting mode returns to the temperature display mode automatically when 90 seconds has passed without any key operation (auto-return function). In this case, the setting is not accepted.

# ALARM TEMPERATURE SETTING





## Setting of high temperature alarm

By setting the high temperature alarm, the alarm lamp and digital temperature indicator blink and alarm buzzer operates (after 15 minutes) when the chamber temperature is over the setting of high temperature alarm. Set the high temperature alarm to protect the stored items against the damage resulting from temperature rise.

- Setting range of high temperature alarm:  
Between chamber temperature plus 5 °C and chamber temperature plus 40 °C
- Initial setting (factory setting): chamber temperature plus 10 °C

Example: Change the high temperature alarm to chamber temperature plus 5 °C from chamber temperature plus 10 °C

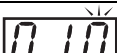
► Following shows a sample setting. Set the desired high temperature alarm according to the condition of use.

	Description of operation	Key operated	Indication after operation
1		----	The current chamber temperature is displayed. 
2	Press the numerical value shift key for about 5 seconds.	▲▲	The first digit blinks. 
3	Set to F01 with the numerical value shift key.	▲▲	When pressed, the figure of settable digit changes. 
4	Press set key.	SET	The current setting (010) is displayed and the first digit blinks. 
5	Set to 005 with the digit shift key and the numerical value shift key.	▲▲	When pressed, the figure of settable digit changes.
		▶▶	When pressed, the changeable digit is shifted. 
6	Press set key.	SET	Set temperature is memorized and the current chamber temperature is displayed. 

◇ The setting mode returns to the temperature display mode automatically when 90 seconds has passed without any key operation (auto-return function). In this case, the setting is not accepted.

# ALARM TEMPERATURE SETTING

## Setting of low temperature alarm

By setting the low temperature alarm, the alarm lamp and digital temperature indicator blink and alarm buzzer operates (after 15 minutes) when the chamber temperature is below the setting of low temperature alarm. Set the low temperature alarm to protect the stored items against the damage resulting from temperature lowering.

- Setting range of low temperature alarm:  
Between chamber temperature minus 5 °C and chamber temperature minus 40 °C
- Initial setting (factory setting): chamber temperature minus 10 °C

Example: Change the low temperature alarm to chamber temperature minus 5 °C from chamber temperature minus 10 °C

► Following shows a sample setting. Set the desired low temperature alarm according to the condition of use.

	Description of operation	Key operated	Indication after operation
1		----	The current chamber temperature is displayed.
2	Press the numerical value shift key for about 5 seconds.	▲▲	The first digit blinks.
3	Set to F02 with the numerical value shift key.	▲▲	When pressed, the figure of settable digit changes.
4	Press set key.	SET	The current setting (-10) is displayed and the first digit blinks.
5	Set to -05 with the digit shift key and the numerical value shift key.	▲▲	When pressed, the figure of settable digit changes.
		▶▶	When pressed, the changeable digit is shifted.
6	Press set key.	SET	Set temperature is memorized and the current chamber temperature is displayed.

◇ The setting mode returns to the temperature display mode automatically when 90 seconds has passed without any key operation (auto-return function). In this case, the setting is not accepted.

# SETTING OF RINGBACK OF ALARM BUZZER

The alarm buzzer operates again after certain period (ringback time) even if the alarm buzzer is silenced by pressing the alarm buzzer stop key (BUZZER) when the same alarm status is continued. Set the ringback time to prevent the misidentify the alarm status.

- Setting range of ringback time: between 10 and 60 minutes (10 minutes interval)  
     Display of setting: between 010 and 060 (000 display shows no ringback)
- Initial setting (factory setting): 30 minutes

The alarm buzzer will not recover once the alarm buzzer is silenced by pressing the alarm buzzer stop key (BUZZER) when the ringback time is set to 000. However, the alarm buzzer will operate if other alarm status is detected.

Example: Change the ringback time to 20 minutes from 30 minutes

► Following shows a sample setting. Set the desired ringback time according to the condition of use.

	Description of operation	Key operated	Indication after operation
1		----	The current chamber temperature is displayed.
2	Press the numerical value shift key for about 5 seconds.		The first digit blinks.
3	Set to F25 with the numerical value shift key and digit shift key..		When pressed, the changeable digit is shifted.
			When pressed, the figure of settable digit changes.
4	Press set key.	SET	The current setting (030) is displayed and the second digit blinks.
5	Set to 020 with the numerical value shift key.		When pressed, the figure of settable digit changes.
6	Press set key.	SET	Ringback time is memorized and the current chamber temperature is displayed.

◇ The setting mode returns to the temperature display mode automatically when 90 seconds has passed without any key operation (auto-return function). In this case, the setting is not accepted.

# SETTING OF COMPRESSOR DELAY TIME









The load on the power supply line at the recovery from the power failure can be reduced when the delay time for compressor start-up is set.

By setting the compressor delay time, the unit can start-up quickly and minimize the rise of chamber temperature after power failure even if multiple units are connected to one power source. Set the compressor delay time to protect the stored items by immediately start-up at the recovery from the power failure.

- ◇ Keep the initial setting (3 minutes) when the power source has enough capacity.
- ◇ It takes some time to get down the chamber temperature if the compressor delay time is set to 5 minutes or more.
  - Setting range of compressor delay time: between 3 minutes and 15 minutes
  - Initial setting (factory setting): 3 minutes

Example: Change the compressor delay time to 4 minutes from 3 minutes

▶ Following shows a sample setting. Set the compressor delay time according to the condition of use.

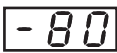
	Description of operation	Key operated	Indication after operation
1		----	The current chamber temperature is displayed. 
2	Press the numerical value shift key for about 5 seconds.		The first digit blinks. 
3	Set to F05 with the numerical value shift key.		When pressed, the figure of settable digit changes. 
4	Press set key.	SET	The current setting (003) is displayed and the first digit blinks. 
5	Set to 004 with the numerical value shift key.		When pressed, the figure of settable digit changes. 
6	Press set key.	SET	The delay time is memorized and the current chamber temperature is displayed. 

◇ The setting mode returns to the temperature display mode automatically when 90 seconds has passed without any key operation (auto-return function). In this case, the setting is not accepted.

# REMOTE ALARM TERMINAL

The alarm status is noticed to a remote location when a remote alarm equipment (commercial item) is connected to the remote alarm terminal. It is recommended to install a remote alarm equipment (commercial item) when the freezer is installed in a desolate location so that an alarm status is noticed to an operator.

- ◇ Contact our representative or agent for the installation of a remote alarm equipment (commercial item).
  - Location of remote alarm terminal: lower right
  - Allowable contact capacity: DC 30 V, 2 A

Contact output:

Terminal	Normal status	Abnormal status
Between COM. and N.O.	open	close
Between COM. and N.C.	close	open

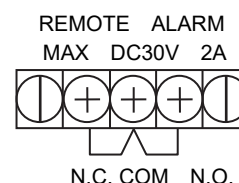

- ◇ The remote alarm terminal is activated as shown in above in the case of:
  - power failure
  - turning off the power switch
  - disconnection of power supply cord from outlet
- ◇ The operation of remote alarm terminal is not conjunction with the alarm buzzer. Accordingly, the operation of remote alarm terminal cannot be canceled by the alarm buzzer stop key (BUZZER).

Use a twisted sealed wire for the connection.  
 Type: UL 2343, UL 2448, UL 2464, UL 2552, UL 2623  
 Length: 30 m max.

# OPERATION CHECK AFTER RECOVERY

After recovery from a power failure, the unit will resume operation automatically with the setting before power failure. Accordingly, there is no need for re-set however, always check the running status after recovery.

- ◇ The set value is memorized by nonvolatile memory during power failure.

**⚠ CAUTION**  
 After recovery from a power failure, always check the unit starts the operation normally with the setting before power failure.

# ALARM FUNCTIONS

This unit has the alarm functions shown below.

Alarms	Situation	Indication	Alarm buzzer	Remote alarm
High temperature alarm	If the chamber temp. is higher than the high temp. alarm setting. [page 17]	Alarm lamp blinks. Chamber temp. blinks.	Intermittent tone with 15 minutes delay.	Alarm status with 15 minutes delay.
Low temperature alarm	If the chamber temp. is lower than the low temp. alarm setting. [page 18]			
Power failure alarm	At power failure. If the power switch is off. If the power supply cord is unplugged.	Alarm lamp blinks.	Intermittent tone.	Alarm status.

◇ When the operation is started in high ambient temperature, the filter check lamp sometimes lights and alarm buzzer sounds. In this case, the filter check lamp and alarm buzzer are off automatically when the chamber temperature or ambient temperature is getting lower.

◇ The chamber temperature is displayed for 5 seconds by pressing alarm buzzer stop key (BUZZER) during power failure alarm. Then the alarm buzzer is stopped. The alarm lamp keeps blinking.

# SAFETY FUNCTIONS

This unit has the safety functions shown below.

Safety	Situation	Indication, Buzzer	Safety operation or Action
Filter check	When the condenser filter is clogged.	Filter check lamp lights. Intermittent tone.	Clean the condenser filter. [page 24]
Battery check	When about 3 years have passed with power switch ON. (time to replace the battery for power failure alarm)	Battery check lamp lights.	Contact our sales representative or agent for replacement.
Fan motor check	When about 6 years have passed with power switch ON. (time to replace the fan motor)	Battery check lamp blinks.	
Lock of chamber temperature	When the key lock is ON (L 1).	---	The change of chamber temperature setting is disable.
Auto-return	When there is no key pressing in setting mode for 90 seconds.	---	Finishing of setting mode and returning to temp. display mode.

◇ A battery for power failure alarm is a wear-out part. It is recommended to replace the battery about every 3 years. Contact our sales representative or agent at the time of replacement of the battery.

◇ A fan motor is a wear-out part. It is recommended to replace the fan motor about every 6 years. Contact our sales representative or agent at the time of replacement of the fan motor.



# SELF DIAGNOSTIC FUNCTIONS

This unit has the self diagnostic functions shown below.

Self diagnostic	Situation	Indication	Alarm buzzer	Remote alarm
Sensor abnormality	If the thermal sensor is disconnected.	Alarm lamp blinks. E01 and chamber temp. is displayed alternately.	Intermittent tone.	Alarm status
	If the thermal sensor is short-circuited.	Alarm lamp blinks. E02 and chamber temp. is displayed alternately.		
	If the cascade sensor is disconnected.	Alarm lamp blinks. E03 and chamber temp. is displayed alternately.		
	If the cascade sensor is short-circuited.	Alarm lamp blinks. E04 and chamber temp. is displayed alternately.		
	If the filter sensor is disconnected.	Alarm lamp blinks. E05 and chamber temp. is displayed alternately.		
	If the filter sensor is short-circuited.	Alarm lamp blinks. E06 and chamber temp. is displayed alternately.		
	If the ambient temperature sensor is disconnected.	Alarm lamp blinks. E07 and chamber temp. is displayed alternately.		
	If the ambient temperature sensor is short-circuited.	Alarm lamp blinks. E08 and chamber temp. is displayed alternately.		
Battery switch check	When the battery switch is OFF at the time of alarm test.	Alarm lamp blinks. E09 blinks.	---	---
Condenser temp. abnormality	In the event of failure of fan motor for cooling the compressor	E10 and chamber temp. is displayed alternately.	Intermittent tone.	Alarm status

✧ When an error code (E01 to E10, except for E09) is displayed, contact our sales representative or agent.

✧ In the case of E09 blinking, turn on the battery switch.

# ROUTINE MAINTENANCE

## **⚠ WARNING**

**Always disconnect the power supply to the unit prior to any repair or maintenance** of the unit in order to prevent electric shock or injury.

**Ensure you do not inhale or consume medication or aerosols** from around the unit at the time of maintenance. These may be harmful to your health.

## **Cleaning of exterior, interior, and accessories**

Use a dry cloth to wipe off small amounts of dirt on the outside and inside of the unit and all accessories. If the outside panels are dirty, clean them with a diluted neutral dishwashing detergent.

Wipe off the condensation on the glass or exterior of the cabinet with a dry soft cloth.

◇ Undiluted detergent can damage the plastic components. For the dilution, refer to the instruction of the detergent.

◇ After the cleaning with the diluted detergent, always wipe it off with a wet cloth. Then wipe off the cabinet or accessories with a dry cloth.

### **<Important>**

- Never pour water onto or into the unit. Doing so can damage the electric insulation and cause failure.
- Always replace the accessories removed for the cleaning to keep the intended performance.

## **Cleaning of condenser filter**

This unit is provided with the filter check lamp on the control panel. Clean the condenser filter when this lamp lights and alarm buzzer sounds. Clean the condenser filter once a month even if the filter check lamp is not on since a clogged condenser filter may cause shorter compressor life as well as the poor cooling.

Clean the condenser filter by the procedure below.

1. Open the grille by pulling it to you as shown in the figure.
2. Take out the condenser filter.
3. Wash the condenser filter with water.
4. Replace the condenser filter and the grille.
5. Check that the filter check lamp is off and alarm buzzer is silent in the event the filter check lamp lit and alarm buzzer sounded.

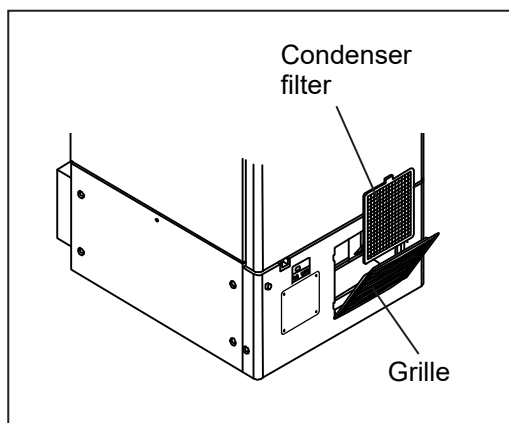

## **⚠ WARNING**

**Do not touch a condenser directly when the condenser filter is removed for cleaning.** The condenser is hot and may cause injury.

# ROUTINE MAINTENANCE

## Defrosting of inside wall

The frost is built at the upper portion of the chamber and inner door. The excessive frost possibly make some gap between the cabinet and magnetic door gasket, which may cause poor cooling. Remove the frost on the inner door with a scraper enclosed with the unit. Following shows the procedure for removing the chamber frost.

**Note:** For removing the frost, do not use a tool with sharp edge such as a knife or a screw driver.

1. Turn off the switch of backup cooling kit if it is installed.
2. Take out and transfer all the contents to another freezer or a container which is refrigerated by liquid carbon dioxide or dry ice.
3. Turn off the power switch and battery switch.
4. Open the outer door and inner door. Remove the inner door by lifting up as shown in the figure.
5. Leave the freezer as it is.
6. Wipe up the water accumulated on the bottom of the chamber with a dry cloth.
7. After cleaning the chamber and inner door, replace the inner door and start up the unit according to the procedure on page 15.
8. Put back the articles into the sufficiently cooled freezer chamber.

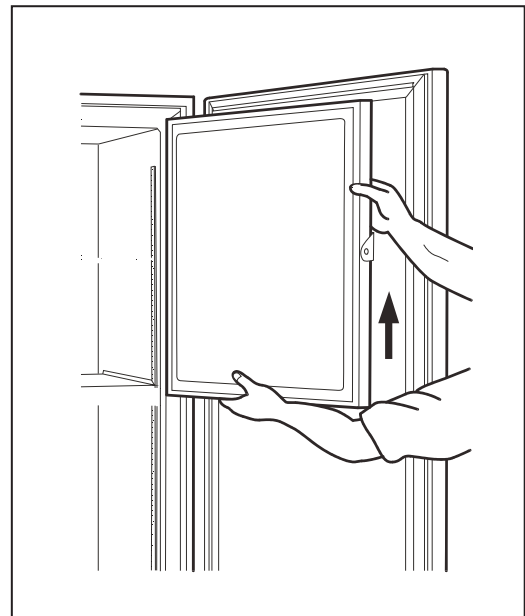

# CALIBRATION

During running operation, the following service works must be performed;

- Perform temperature calibration at least once a year.

Contact our sales representative or agent.

# REPLACEMENT OF WEAR-OUT PARTS

## Replacement of battery for power failure alarm

Replace the battery for power failure alarm about every 3 years (when the battery check lamp lights) to ensure the alarm is operated in the event of power failure. Contact our sales representative or agent for the replacement of battery when the battery check lamp lights.

◇ The alarm function (blink of alarm lamp, sound of buzzer) will not operate when the battery for power failure alarm is flat.

◇ The alarm lamp blinks and the buzzer sounds by the battery for power failure alarm. The regular replacement of the battery for power failure alarm is important to prevent the rise of chamber temperature in the case of unexpected situation.

### <Important>

The used battery is a recyclable precious resource. Do not dispose of the battery. Always follow the procedure for recycling.

### **WARNING**

**The replacement of the battery for power failure alarm should be executed by a qualified engineer or a service personnel only.** The replacement of the battery for power failure alarm involves the risk of electric shock.

## Replacement of fan motor

Replace the fan motor for cooling circuit about every 6 years (when the battery check lamp blinks) to ensure the appropriate operation of freezer. Contact our sales representative or agent for the replacement of fan motor for cooling circuit when the battery check lamp blinks.

◇ The appropriate operation of the unit is maintained by cooling the compressor with a fan. The motor to operate the fan (fan motor for cooling circuit) is a wear-out part. A degraded fan motor may result in the poor cooling performance.

# TROUBLESHOOTING

If the unit malfunctions, check out the following before calling for service.

Malfunction	Check/Remedy
The chamber is not cooled at all	<ul style="list-style-type: none"> <li><input type="checkbox"/> The circuit breaker of power source is active.</li> <li><input type="checkbox"/> The voltage is too low. In this case, call an electrician.</li> <li><input type="checkbox"/> The power switch is not ON.</li> </ul>
The cooling is poor	<ul style="list-style-type: none"> <li><input type="checkbox"/> The large amount of articles (load) is stored in the chamber at one time.</li> <li><input type="checkbox"/> The ambient temperature is too high.</li> <li><input type="checkbox"/> The inner door latch is not closed completely. The outer door is not closed firmly. (The frost or ice between the cabinet and magnetic door gasket possibly prevents door seal.)</li> <li><input type="checkbox"/> The air intake vent is blocked.</li> <li><input type="checkbox"/> The condenser filter is clogged. Always clean the condenser filter when the filter check lamp lights.</li> <li><input type="checkbox"/> The set temperature is not inputted properly.</li> <li><input type="checkbox"/> The freezer is not away from the direct sunlight.</li> <li><input type="checkbox"/> There is any heating source near the freezer.</li> <li><input type="checkbox"/> A rubber cap and insulation for the access port are not set correctly.</li> </ul>
Alarm test key cannot actuate the alarm	<ul style="list-style-type: none"> <li><input type="checkbox"/> The battery switch is not ON.</li> <li><input type="checkbox"/> When only the alarm buzzer or only the alarm lamp is actuated by the alarm test key, the unactuated part is out of order, and must be replaced.</li> </ul>
Noise	<ul style="list-style-type: none"> <li><input type="checkbox"/> The freezer is not installed on the sturdy floor.</li> <li><input type="checkbox"/> There is anything touching the frame.</li> <li><input type="checkbox"/> The freezer is not leveled with the leveling feet.</li> <li><input type="checkbox"/> The freezer is in the status immediately after start up.</li> </ul> <p>The unit sometimes causes a noise when the chamber temperature is high due to the large load. The noise gets less and less accompanying with the cooling of the chamber.</p>
Back-up test switch does not operate normally (when the backup cooling kit is installed)	<ul style="list-style-type: none"> <li><input type="checkbox"/> The liquefied CO<sub>2</sub> cylinder is empty.</li> <li><input type="checkbox"/> The valve of liquefied CO<sub>2</sub> cylinder is not opened.</li> <li><input type="checkbox"/> The ambient temperature is too high. In this case, move the tank to a cool location.</li> </ul> <p>Inquire at liquid carbon dioxide suppliers about its check, adjustment, installation, or move.</p>

**Note:**

If the malfunction is not eliminated after checking the above items, or the malfunction is not shown in the above table, contact our sales representative or agent.

# DISPOSAL OF UNIT

## WARNING

If the unit is to be stored unused in an unsupervised area for an extended period **ensure that children do not have access and doors cannot be closed completely.**

**The disposal of the unit should be accomplished by appropriate personnel. Always remove doors** to prevent accidents such as suffocation.

## Recycle of battery

The unit contains a rechargeable battery. The battery is recyclable. At the end of its useful life, check with your local solid officials option or proper disposal.



**Ni-MH**

- Label indication is obliged to comply with Japanese battery regulation.



- Label indication is obliged to comply with Taiwanese battery regulation.

## Decontamination of unit

Before disposing a biomedical freezer with biohazardous danger, decontaminate the biomedical freezer to the extent possible by the user

# DISPOSAL OF UNIT

(English)

## Disposal of Old Equipment and Batteries

Only for European Union and countries with recycling systems



These symbols on the products, packaging, and/or accompanying documents mean that used electrical and electronic products and batteries must not be mixed with general household waste.

For proper treatment, recovery and recycling of old products and used batteries, please take them to applicable collection points in accordance with your national legislation.

By disposing of them correctly, you will help to save valuable resources and prevent any potential negative effects on human health and the environment.

For more information about collection and recycling, please contact your local municipality.



Penalties may be applicable for incorrect disposal of this waste, in accordance with national legislation.

### Note for the battery symbol (bottom symbol):

This symbol might be used in combination with a chemical symbol. In this case it complies with the requirement set by the Directive for the chemical involved.

(German)

## Entsorgung von Altgeräten und Batterien

Nur für die Europäische Union und Länder mit Recyclingsystemen



Dieses Symbol, auf den Produkten, der Verpackung und/oder den Begleitdokumenten, bedeutet, dass gebrauchte elektrische und elektronische Produkte sowie Batterien nicht in den allgemeinen Hausmüll gegeben werden dürfen.

Bitte führen Sie alte Produkte und verbrauchte Batterien zur Behandlung, Aufarbeitung bzw. zum Recycling gemäß den gesetzlichen Bestimmungen den zuständigen Sammelpunkten zu. Endnutzer sind in Deutschland gesetzlich zur Rückgabe von Altbatterien an einer geeigneten Annahmestelle verpflichtet. Batterien können im Handelsgeschäft unentgeltlich zurückgegeben werden.

Indem Sie diese Produkte und Batterien ordnungsgemäß entsorgen, helfen Sie dabei, wertvolle Ressourcen zu schützen und eventuelle negative Auswirkungen auf die menschliche Gesundheit und die Umwelt zu vermeiden.

Für mehr Informationen zu Sammlung und Recycling, wenden Sie sich bitte an Ihren örtlichen Abfallentsorgungsdienstleister.

Gemäß Landesvorschriften können wegen nicht ordnungsgemäßer Entsorgung dieses Abfalls Strafge­lder verhängt werden.



### Hinweis für das Batteriesymbol (Symbol unten):

Dieses Symbol kann in Kombination mit einem chemischen Symbol abgebildet sein. In diesem Fall erfolgt dieses auf Grund der Anforderungen derjenigen Richtlinien, die für die betreffende Chemikalie erlassen wurden.

# DISPOSAL OF UNIT

(French)

## L'élimination des équipements et des batteries usagés

**Applicable uniquement dans les pays membres de l'Union européenne et les pays disposant de systèmes de recyclage.**



Apposé sur le produit lui-même, sur son emballage, ou figurant dans la documentation qui l'accompagne, ce pictogramme indique que les piles, appareils électriques et électroniques usagés, doivent être séparés des ordures ménagères.



Afin de permettre le traitement, la valorisation et le recyclage adéquats des piles et des appareils usagés, veuillez les porter à l'un des points de collecte prévus, conformément à la législation nationale en vigueur.

En les éliminant conformément à la réglementation en vigueur, vous contribuez à éviter le gaspillage de ressources précieuses ainsi qu'à protéger la santé humaine et l'environnement.

Pour de plus amples renseignements sur la collecte et le recyclage, veuillez vous renseigner auprès des collectivités locales.

Le non-respect de la réglementation relative à l'élimination des déchets est passible d'une peine d'amende.



### **Note relative au pictogramme à apposer sur les piles (pictogramme du bas) :**

Si ce pictogramme est combiné avec un symbole chimique, il répond également aux exigences posées par la Directive relative au produit chimique concerné.

(Spanish)

## Eliminación de Aparatos Viejos y de Pilas y Baterías

**Solamente para la Unión Europea y países con sistemas de reciclado.**



Estos símbolos en los productos, su embalaje o en los documentos que los acompañen significan que los productos eléctricos y electrónicos y pilas y baterías usadas no deben mezclarse con los residuos domésticos.



Para el adecuado tratamiento, recuperación y reciclaje de los productos viejos y pilas y baterías usadas llévelos a los puntos de recogida de acuerdo con su legislación nacional. En España, los usuarios están obligados a entregar las pilas en los correspondientes puntos de recogida. En cualquier caso, la entrega por los usuarios será sin coste alguno para éstos. El coste de la gestión medioambiental de los residuos de pilas, acumuladores y baterías está incluido en el precio de venta.

Si los elimina correctamente ayudará a preservar valiosos recursos y evitará potenciales efectos negativos sobre la salud de las personas y sobre el medio ambiente.

Para más información sobre la recogida u reciclaje, por favor contacte con su ayuntamiento.

Puede haber sanciones por una incorrecta eliminación de este residuo, de acuerdo con la legislación nacional.



### **Nota para el símbolo de pilas y baterías (símbolo debajo):**

Este símbolo puede usarse en combinación con el símbolo químico. En este caso, cumple con los requisitos de la Directiva del producto químico indicado.



# DISPOSAL OF UNIT

(Portuguese)

## Eliminação de Equipamentos Usados e Baterias

### Apenas para a União Europeia e países com sistemas de reciclagem



Estes símbolos nos produtos, embalagens, e/ou documentos que os acompanham indicam que os produtos elétricos e eletrónicos e as baterias usados não podem ser misturados com os resíduos urbanos indiferenciados.



Para um tratamento adequado, reutilização e reciclagem de produtos e baterias usados, solicitamos que os coloque em pontos de recolha próprios, em conformidade com a respetiva legislação nacional.

Ao eliminar estes produtos corretamente estará a ajudar a poupar recursos valiosos e a prevenir quaisquer potenciais efeitos negativos sobre o ambiente e a saúde humana.

Para mais informações acerca da recolha e reciclagem, por favor contacte a sua autarquia local.

De acordo com a legislação nacional podem ser aplicadas contraordenações pela eliminação incorreta destes resíduos.



#### **Nota para o símbolo da bateria (símbolo na parte inferior):**

Este símbolo pode ser utilizado conjuntamente com um símbolo químico. Neste caso estará em conformidade com o estabelecido na Diretiva referente aos produtos químicos em causa.

(Italian)

## Smaltimento di vecchie apparecchiature e batterie usate

### Solo per Unione Europea e Nazioni con sistemi di raccolta e smaltimento



Questi simboli sui prodotti, sull'imballaggio e/o sulle documentazioni o manuali accompagnanti i prodotti indicano che i prodotti elettrici, elettronici e le batterie usate non devono essere buttati nei rifiuti domestici generici.



Per un trattamento adeguato, recupero e riciclaggio di vecchi prodotti e batterie usate vi invitiamo a portarli negli appositi punti di raccolta secondo la legislazione vigente nel vostro paese.

Con uno smaltimento corretto, contribuirete a salvare importanti risorse e ad evitare i potenziali effetti negativi sulla salute umana e sull'ambiente.

Per ulteriori informazioni su raccolta e riciclaggio, vi invitiamo a contattare il vostro comune.

Lo smaltimento non corretto di questi rifiuti potrebbe comportare sanzioni in accordo con la legislazione nazionale.



#### **Note per il simbolo batterie (simbolo sotto):**

Questo simbolo può essere usato in combinazione con un simbolo chimico. In questo caso è conforme ai requisiti indicati dalla Direttiva per il prodotto chimico in questione.

# DISPOSAL OF UNIT

(Dutch)

## Het ontdoen van oude apparatuur en batterijen.

Enkel voor de Europese Unie en landen met recycle systemen.



Deze symbolen op de producten, verpakkingen en/of begeleidende documenten betekenen dat gebruikte elektrische en elektronische producten en batterijen niet samen mogen worden weggegooid met de rest van het huishoudelijk afval.



Voor een juiste verwerking, hergebruik en recycling van oude producten en batterijen, gelieve deze in te leveren bij de desbetreffende inleverpunten in overeenstemming met uw nationale wetgeving.

Door ze op de juiste wijze weg te gooien, helpt u mee met het besparen van kostbare hulpbronnen en voorkomt u potentiële negatieve effecten op de volksgezondheid en het milieu.

Voor meer informatie over inzameling en recycling kunt u contact opnemen met uw plaatselijke gemeente.

Afhankelijk van uw nationale wetgeving kunnen er boetes worden opgelegd bij het onjuist weggooien van dit soort afval.



**Let op: het batterij symbool (Onderstaand symbool).**

Dit symbool kan in combinatie met een chemisch symbool gebruikt worden. In dit geval volstaan de eisen, die zijn vastgesteld in de richtlijnen van de desbetreffende chemische stof.

(Swedish)

## Avfallshantering av produkter och batterier

Endast för Europeiska Unionen och länder med återvinningssystem



Dessa symboler på produkter, förpackningar och/eller medföljande dokument betyder att förbrukade elektriska och elektroniska produkter och batterier inte får blandas med vanliga hushållssopor.



För att gamla produkter och använda batterier ska hanteras och återvinnas på rätt sätt ska dom lämnas till passande uppsamlingsställe i enlighet med nationella bestämmelser.

Genom att ta göra det korrekt hjälper du till att spara värdefulla resurser och förhindrar eventuella negativa effekter på människors hälsa och på miljön.

För mer information om insamling och återvinning kontakta din kommun.

Olämplig avfallshantering kan beläggas med böter i enlighet med nationella bestämmelser.



**Notering till batterisymbolen (nedanför):**

Denna symbol kan användas i kombination med en kemisk symbol. I detta fall uppfyller den de krav som ställs i direktivet för den aktuella kemikalien.

# TEMPERATURE RECORDER (OPTION)

The chamber temperature can be monitored and recorded by attaching a temperature recorder available as an optional component.

- ✧ For the attachment of a temperature recorder, contact our sales representative or agent.
- ✧ For the usage of the temperature recorder, also refer to an installation sheet enclosed with the temperature recorder.

Main specifications of temperature recorder

	MTR-G85C	MTR-85H
Recording range	Between -100 °C and +40 °C	Between -100 °C and +50 °C
Feed speed of recording paper	1-day/turn, 7-day/turn, 32-day/turn	31-day/batch
Recording paper	Circular type	Strip type
Power source	Supplied from the freezer	Dry cell
Recorder fixing	-----	MDF-S3085
Recorder sensor cover	MTR-C8	MTR-C8

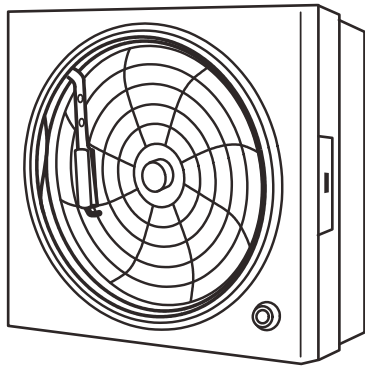

MTR-G85C

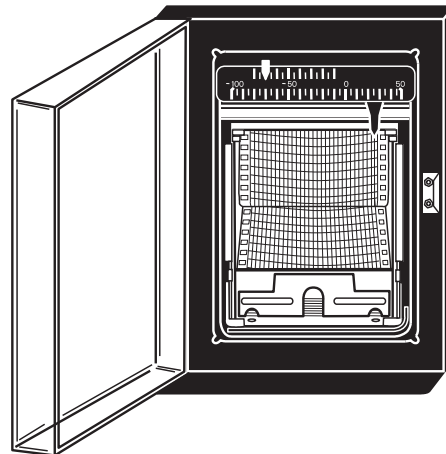

MTR-85H

# TEMPERATURE RECORDER (OPTION)

## Temperature recorder unit of MTR-G85C

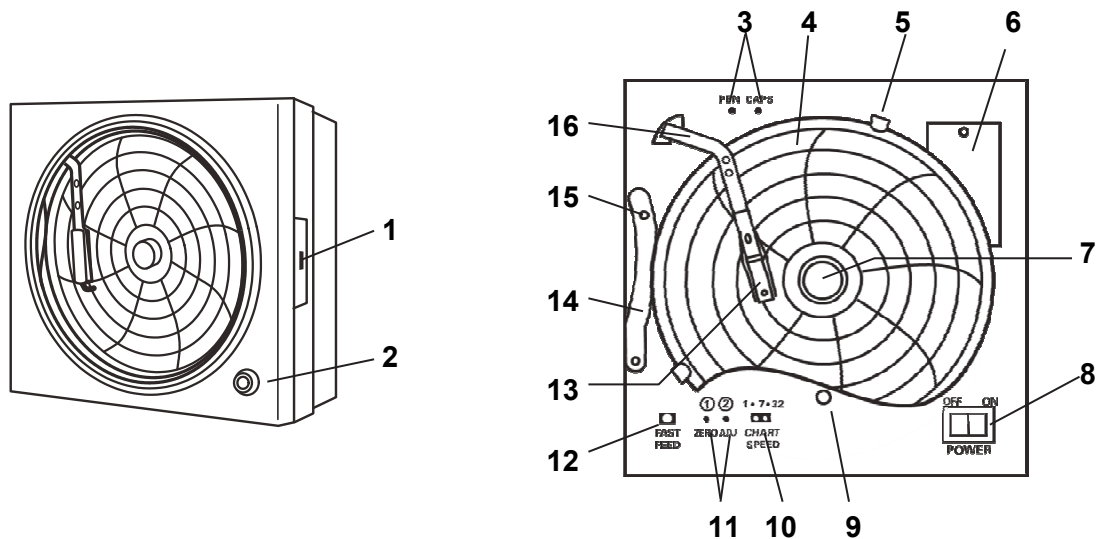

**1. Cover button:** To open the cover, pull the cover forward while pressing the cover button.

**2. Key lock:** Insert the enclosed key and turn to the right while pushing and the cover is locked.

**3. Pen cap holder:** The pen cap that is removed when loading the pen cartridge can be placed on this holder.

**4. Recording chart:** Circular chart with an outer diameter of 155 mm. Always use the specified chart.

**5. Chart guide:** These guides are used to hold down the recording chart. One guide is located at the bottom-left side.

**6. Back-up battery:** An Ni-MH battery is used as a back-up power source. In the event of power failure, the temperature recorder is operated with this battery. The back-up operation is about 24 hours.

**7. Chart hub cover:** This cover is used to hold the recording chart. The recording chart does not feed properly unless this hub cover is present.

**8. Power switch:** This switch is used to turn the power ON and OFF.

**9. Pilot lamp:** A green light is seen through the recording chart when the power is ON. This lamp will not turn ON when the temperature recorder is being powered by the back-up battery.

**10. Chart speed selector:** This selector is used to set the time for one full chart revolution (1, 7 or 32 days).

**11. Zero adjustment screw:** This screw is used to align the pen tip recording value with the previously set value.

**12. Fast feed button:** This button is used to set the loaded chart to the correct time. The speed is 10 minutes/revolution.

◇ Due to the structural design, 2 to 3 seconds may be required before movement starts, even when pushing this button.

**13. Pen cartridge:** The cartridge is red. The pen life is approximately 6 months.

**14. Pen lifter:** Turn clockwise to raise the pen. This function helps to prevent the recording chart from becoming marked when it is removed or when loading a pen cartridge.

**15. Pen lifter stopper:** The pen lifter is placed at this stopper position during recording operation.

**16. Pen arm:** The accessory pen cartridge is attached to this arm.

# TEMPERATURE RECORDER (OPTION)

## Loading the pen cartridge

1. Turn off the power switch.
2. Slightly raise the end of the pen lifter and remove from the pen lifter stopper. Then rotate clockwise (until the pen top is on the pen lifter) as shown in Fig. 1
  - ◇ This helps to prevent the recording chart from becoming marked when it is removed or when loading a pen cartridge.
3. Remove the pen cartridge from the bag and remove its cap.
  - ◇ The cap can be conveniently kept on the cap holder located at the upper left corner.
4. As shown in <1> in Fig. 2, press the both sides of the pen arm as indicated by the arrows to open the head clamp at A and B.
5. As shown in <2> in Fig. 2, position the pen cartridge so that the guide pins fit into the guide holes on the pen arm.
6. As shown in <3> in Fig. 2, press the two sides of the head clamp by the arrows (at A and B) to secure the pen cartridge.  
From the side view, the cartridge should hit perfectly on the pen arm. Confirm the pen arm is attached to both sides of the pen cartridge.
7. Return the pen lifter to the original position and secure with the pen lifter stopper.
8. Turn on the power switch.

### <Important>

Remove the pen cartridge from the pen arm and cover with the cap to avoid the ink evaporation when the recording is stopped for a while.

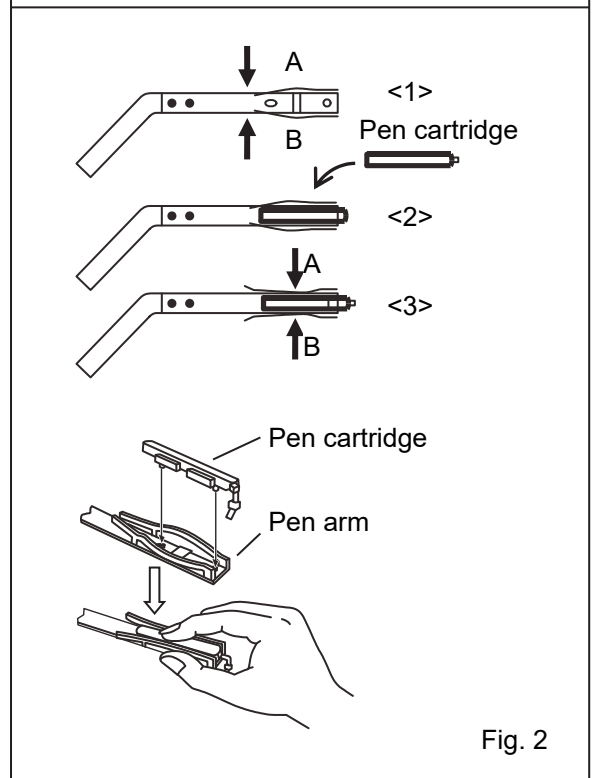
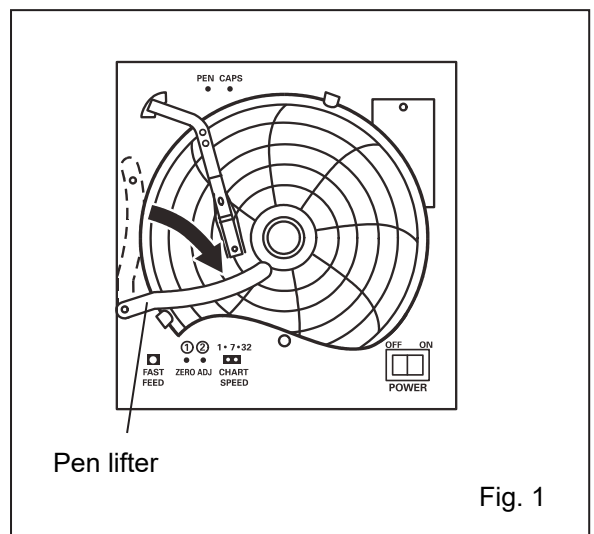

# TEMPERATURE RECORDER (OPTION)

## Setting the start time

1. Turn off the power switch.
2. Place the recording chart at a position slightly in front of the desired time (the recording chart is rotated to the left). [Fig. 1]
3. Turn on the power switch.
4. Set the time by using the fast feed button to quickly rotate the recording chart.
  - ◇ The fast feed button can be used to accurately set the time.

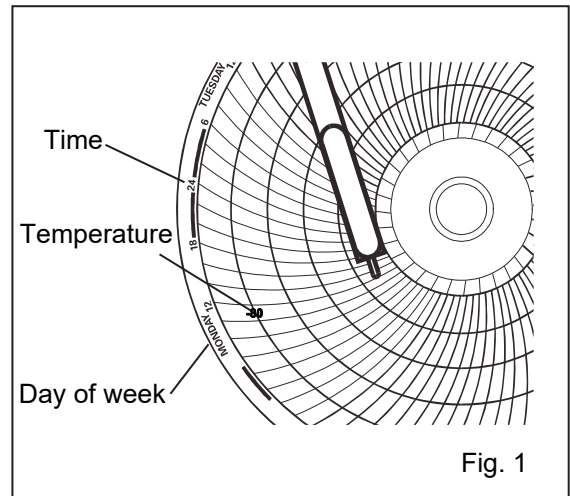

## Replacing the recording chart

1. Turn off the power switch.
2. Slightly raise the end of the pen lifter and remove from the pen lifter stopper. Then rotate clockwise (until the pen top is on the pen lifter) as shown in Fig. 1.
  - ◇ This helps to prevent the recording chart from becoming marked when it is removed or when loading a pen cartridge.
3. Remove the chart hub cover, and then replace the recording chart.
4. Place the chart hub cover.
5. Confirm the new recording chart is inside of the chart guides.
6. Set the start time of the recording.

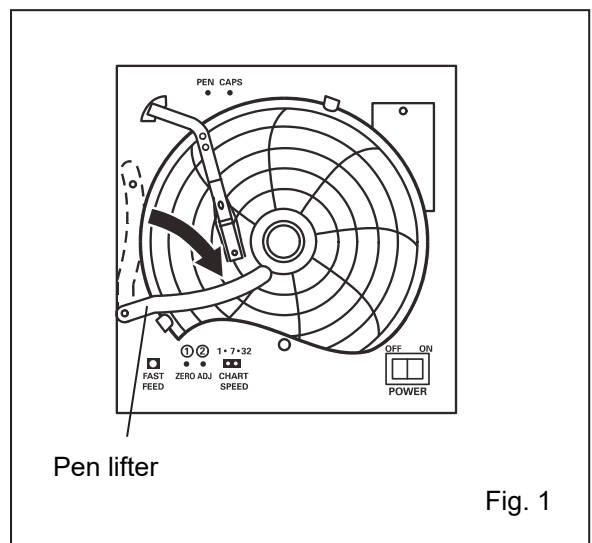

# TEMPERATURE RECORDER (OPTION)

## Temperature recorder unit of MTR-85H

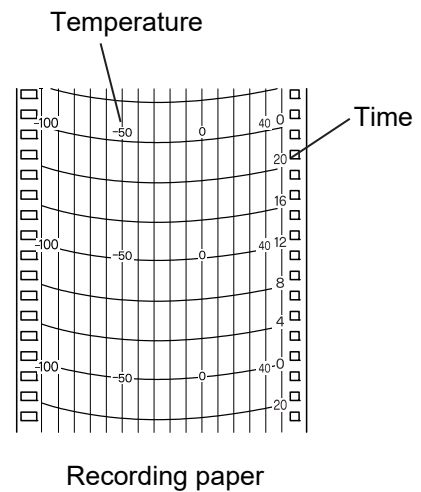
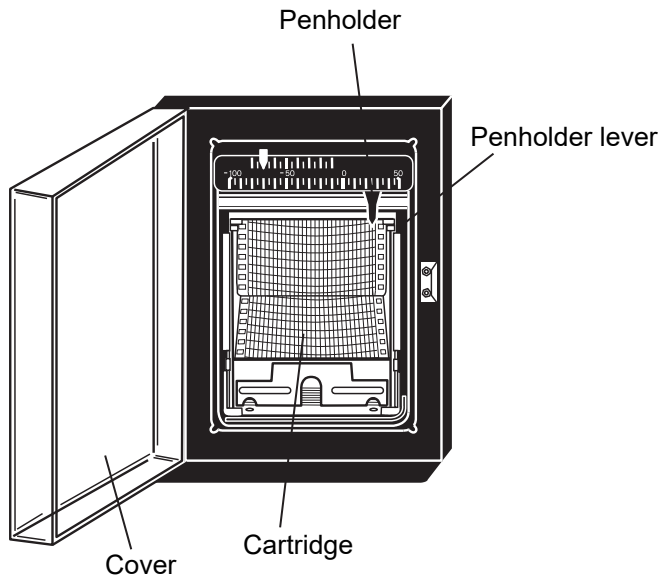

## Loading the ink pen

1. Open the cover and let down the penholder lever. With this operation, the pen point is apart from the recording paper.

2. Pull the cartridge out of the mounted position as shown in Fig. 1 and Fig. 2.

3. Remove an ink pen in the penholder and set a new ink pen properly keeping the penholder with the left hand as shown in Fig. 3.

✧ Improper setting will result in inaccurate temperature recording.

4. To replace the cartridge to the recorder, insert it horizontally first with the slot of the cartridge on the projection on the recorder and then set up the cartridge vertically.

5. Lift up the penholder lever and close the cover.

6. Check that the pen tip contacts with the recording paper properly.

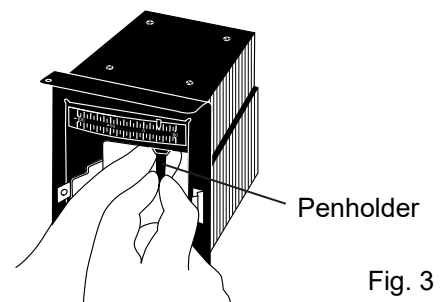
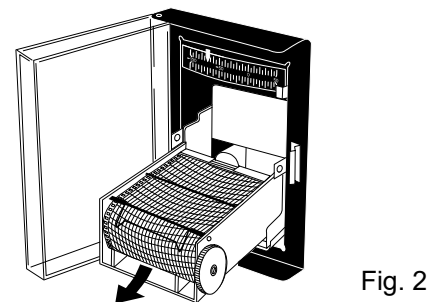
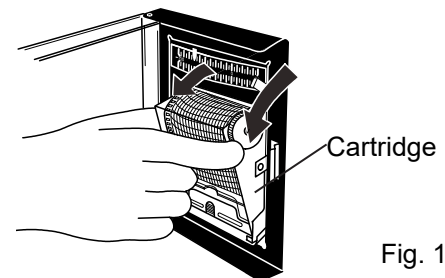

# TEMPERATURE RECORDER (OPTION)

## Loading the recording paper

1. Open the cover and let down the penholder lever. With this operation, the pen point is apart from the recording paper.
2. Pull the cartridge out of the mounted position as shown in Fig. 1 and Fig. 2.
3. Set a new recording paper in place on the rear bottom of the cartridge. Set the hole on the recording paper in the cog of the recording paper driving assembly and feed the recording paper in the direction of the arrow by driving the cog wheel as shown in Fig. 3.
4. Adjust the recording paper properly according to the marking of date and time.
5. To replace the cartridge to the recorder, insert it horizontally first with the slot of the cartridge on the projection on the recorder and then set up the cartridge vertically.
6. Lift up the penholder lever and close the cover.
7. Check that the pen tip contacts with the recording paper properly.

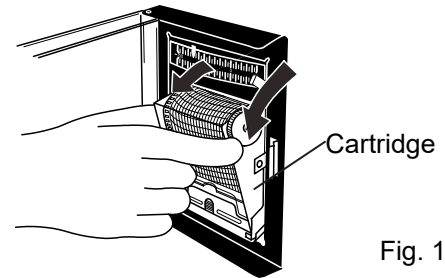

Fig. 1

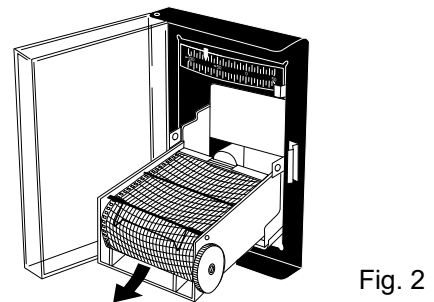

Fig. 2

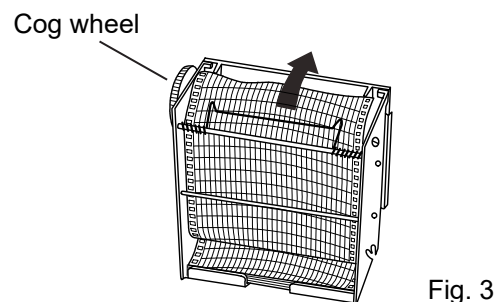

Fig. 3



# TEMPERATURE RECORDER (OPTION)

## Replacing the dry cell

1. Open the cover and let down the penholder lever. With this operation, the pen point is apart from the recording paper.
2. Pull the cartridge out of the mounted position as shown in Fig. 1 and Fig. 2.
3. Open the case cover of dry cell at the left bottom [Fig. 3].  
◇ The case cover is fixed by a stopper on the right. Pull the stopper outward to open the case cover.
4. Remove a dry cell and set a new dry cell in the case with its minus pole positioned backward.
5. Close the case cover.
6. To replace the cartridge to the recorder, insert it horizontally first with the slot of the cartridge on the projection on the recorder and then set up the cartridge vertically.
7. Lift up the penholder lever and close the cover.

### Note :

This temperature recorder is designed for the manganese dry cell and the alkaline dry cell.

Do not use a rechargeable battery because the initial voltage of such battery is low. The rechargeable battery may cause the malfunction of recorder or shorten the battery life significantly.

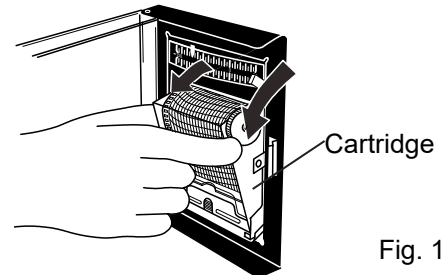

Fig. 1

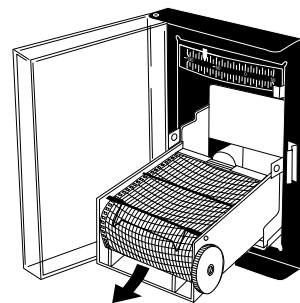

Fig. 2

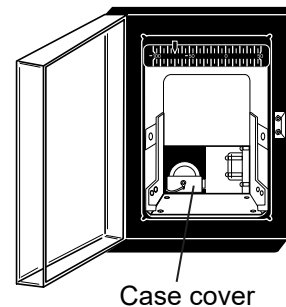

Fig. 3

# BACKUP COOLING KIT (OPTION)

It is recommended to install an optional backup cooling kit for the precaution against the chamber temperature rise resulting from the operation stop due to the power failure and so on. The backup cooling kit will operate during an emergency as a guard of the stored items.

✧ Contact our sales representative or agent for the purchase of backup cooling kit.

Following shows the time to keep chamber temperature at -70 °C by using the optional backup cooling kit.

✧ For the usage of the backup cooling kit, refer to an installation sheet enclosed with the backup cooling kit.

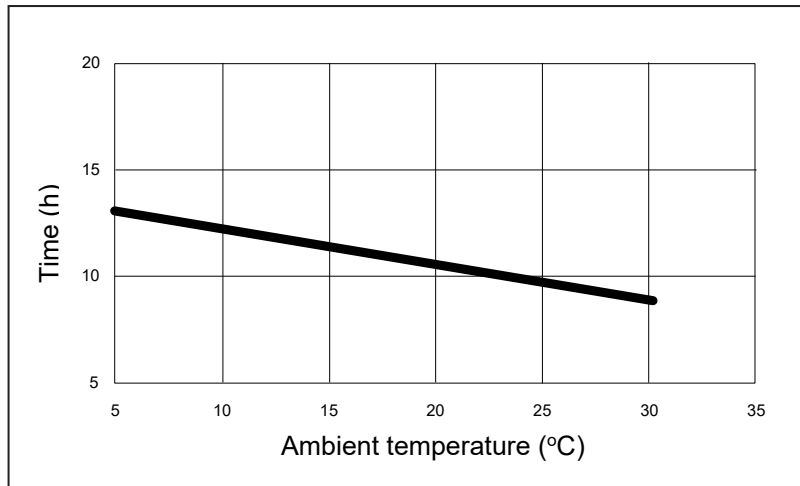

✧ The above data is the experimental value using a liquid CO<sub>2</sub> of 30 L without load.

# INVENTORY RACK (OPTION)

An optional inventory rack is useful to store the precious materials in the chamber effectively. When the inventory rack is used, it is necessary to change the location of shelf stopper. Set the shelf stopper as shown in the figure below.

✧ Contact our sales representative or agent for the purchase of inventory rack.

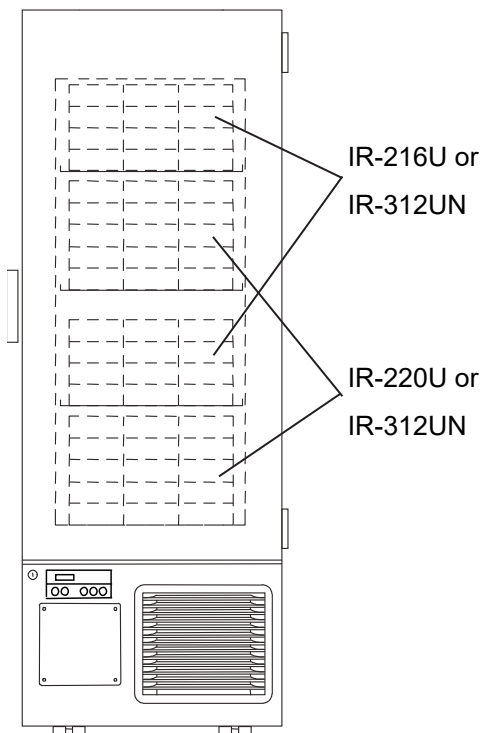
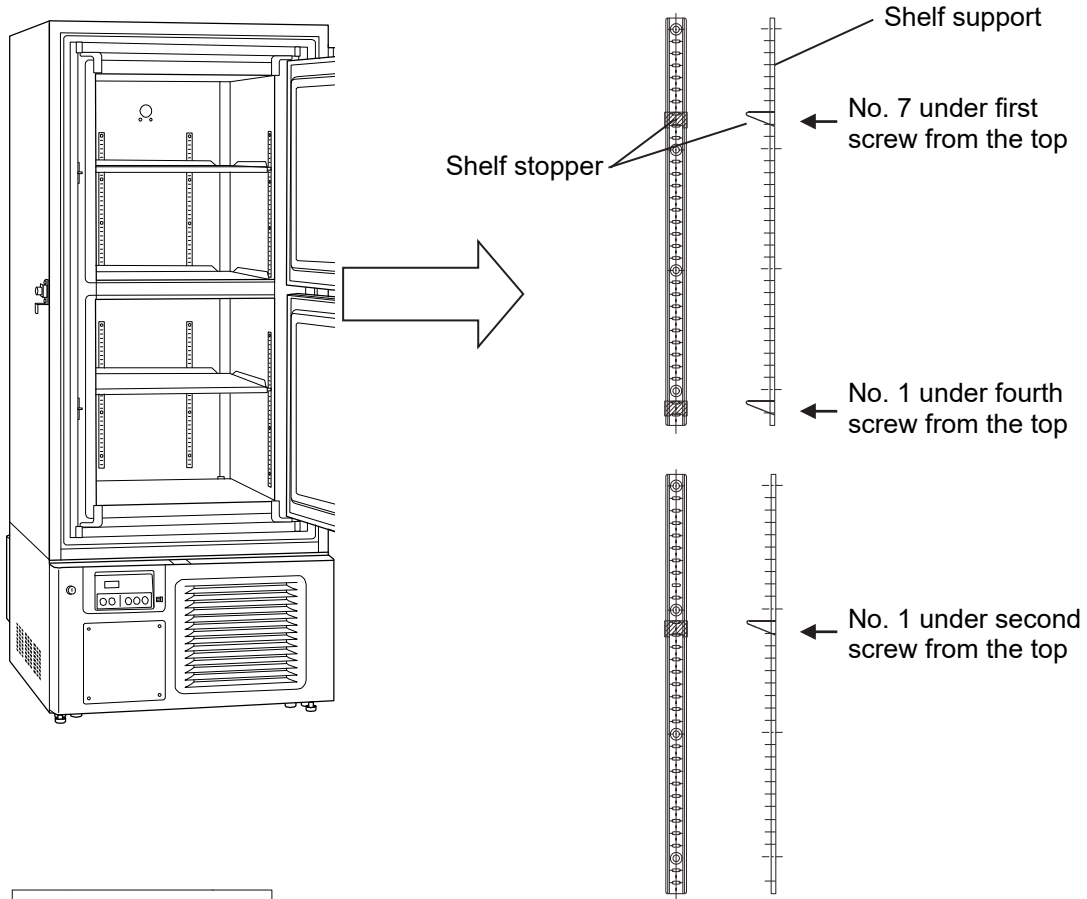

<Attachment of shelf stopper>

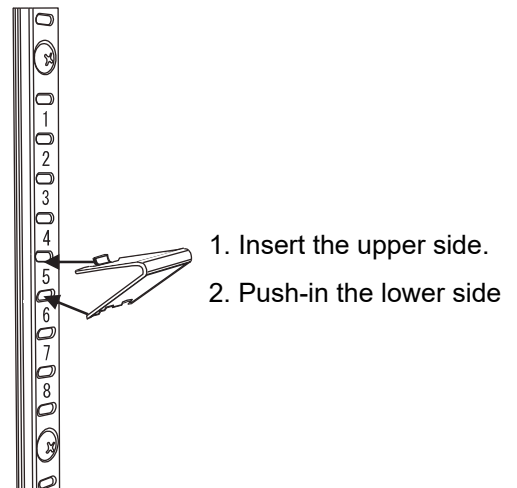

# SPECIFICATIONS

Product name	Ultra-Low Temperature Freezer MDF-DU300H
Medical purpose	Storage of cells, organs, DNAs, plasma.
External dimensions	W750 mm x D870 mm x H1830 mm
Internal dimensions	W490 mm x D600 mm x H1140 mm
Effective capacity	333 L
Exterior	Painted steel
Interior	Painted steel
Outer door	Painted steel
Inner door	ABS resin panel with stainless frame, 2 doors
Shelf	Stainless steel, 3 shelves (adjustable) W464 mm x D535 mm, Load; 50 kg/shelf
Access port	17 mm diameter, 3 locations (back, bottom left/right corner)
Insulation	Rigid polyurethane foamed-in place
Compressor	High stage side; Hermetic type, Output; 450 W Low stage side; Hermetic type, Output; 450 W
Evaporator	Tube on sheet type
Condenser	High stage side; Fin and tube type, Low stage side; Shell and tube type
Refrigerant	High stage side; R-290, Low stage side; R-170
Temperature controller	Microcomputer control system
Temperature display	Digital display
Thermal sensor	Platinum resistance (Pt 1000Ω)
Alarm	High temp. alarm, Low temp. alarm, Power failure alarm
Remote alarm contact	Allowable contact capacity: DC 30 V, 2 A
Battery	Nickel-metal-hydride battery, DC 6 V, 1100 mAh, Auto-recharge
Accessories	1 set of key, 1 scraper
Weight	241 kg
Optional component	Temperature recorder (MTR-85H) + Recorder fixing (MTR-S3085) + Recorder sensor cover (MTR-C8) Temperature recorder (MTR-G85C) + Recorder sensor cover (MTR-C8) Backup cooling kit (CVK-UB2): LCO <sub>2</sub> Inventory rack (IR-A216U, IR-220U, IR-312UN) Interface board (MTR-480), LAN interface board (MTR-L03) *

\* For the data acquisition system MTR-5000 user only. Contact our sales representative or agent for purchase.

- ◇ Design or specifications will be subject to change without notice.
- ◇ Refer to the updated catalog when ordering an optional component.

# PERFORMANCE

Product name	Ultra-Low Temperature Freezer MDF-DU300H
Model number	MDF-DU300H-PE
Cooling performance	-86 °C at the center of the chamber (ambient temperature; 30 °C, no load)
Temperature control range	-86 °C to -50 °C (ambient temperature; 30 °C, no load)
Power voltage	AC 230 V/240 V
Rated frequency	50 Hz
Rated power consumption	405 W/435 W
Noise level	52 dB [A] (background noise; 20 dB)
Maximum pressure	2.6 MPa

- ◇ The above data is measured based on our internal basis.
- ◇ Design or specifications will be subject to change without notice.
- ◇ The unit with CE mark complies with EU directives.

# EMC PERFORMANCE

Emission: EN 61326-1

Immunity: EN 61326-1

This product is intended for use in a basic electromagnetic environment.

## CAUTION

Please fill in this form before servicing.  
Hand over this form to the service engineer to keep for his and your safety.

### Safety check sheet

1. Freezer contents :

- Risk of infection: Yes No  
Risk of toxicity: Yes No  
Risk from radioactive sources: Yes No

(List all potentially hazardous materials that have been stored in this unit.)

Notes :

2. Contamination of the unit

Unit interior

- No contamination Yes No  
Decontaminated Yes No  
Contaminated Yes No

Others:

3. Instructions for safe repair/maintenance/disposal of the unit

- a) The unit is safe to work on Yes No  
b) There is some danger (see below) Yes No

Procedure to be adhered to in order to reduce safety risk indicated in b) below.

Date :

Signature :

Address, Division :

Telephone :

Product name: Ultra-low temperature freezer	Model: MDF-	Serial number:	Date of installation:
---	----------------	----------------	-----------------------

Please decontaminate the unit yourself before calling the service engineer.



## **Original Operating Instructions**

< EU countries only >



**PHC Europe B.V.**

Nijverheidsweg 120 4879 AZ Etten Leur, The Netherlands



**PHC Corporation**

1-1-1 Sakada, Oizumi-machi, Ora-gun, Gunma 370-0596, Japan